

DIN RECEPTACLES

RIGHT-ANGLE SHIELDED RECEPTACLE for printed circuit board mounting

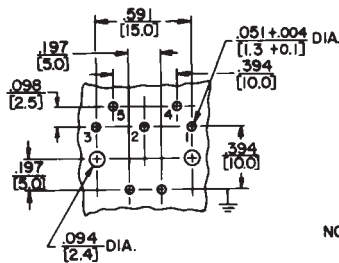

RECOMMENDED PC BOARD LAYOUT (Component Side)

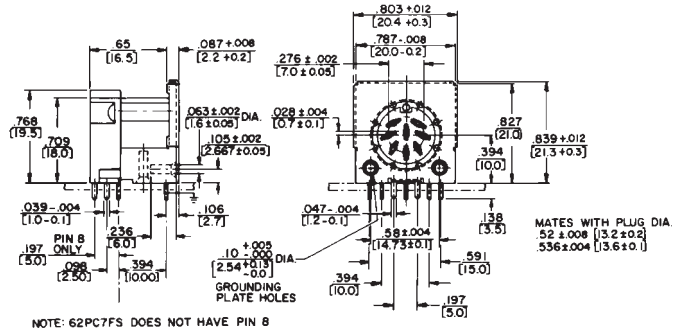
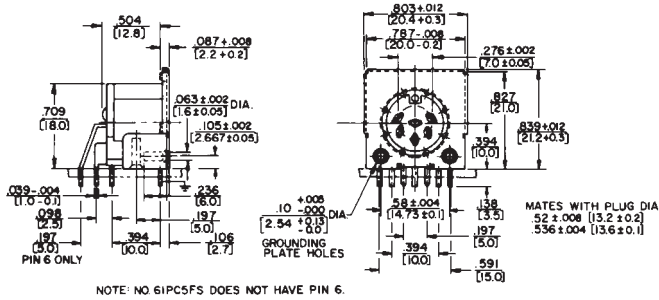
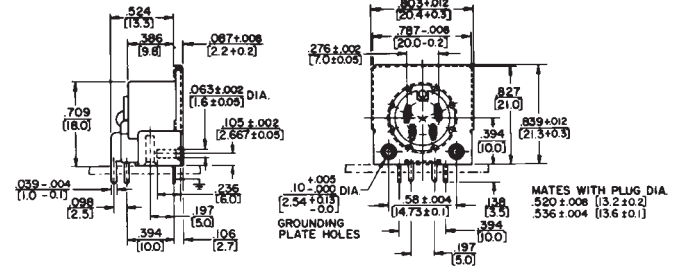
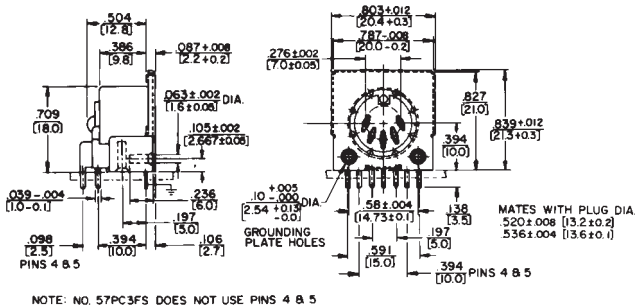
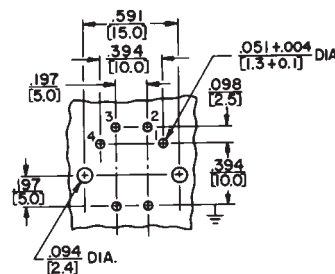

RECOMMENDED PC BOARD LAYOUT (Component Side)

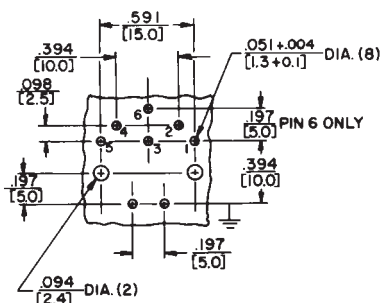

RECOMMENDED PC BOARD LAYOUT (Component Side)

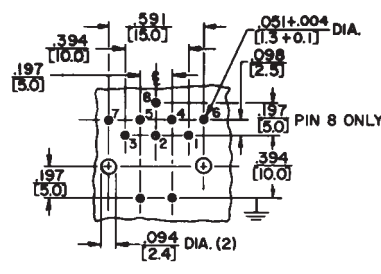

RECOMMENDED PC BOARD LAYOUT (Component Side)

DIMENSIONS ARE FOR REFERENCE ONLY Inch
(mm)

NOTE: Contact your Switchcraft Representative for price and delivery.